

Capteur de manque de liquide de rinçage

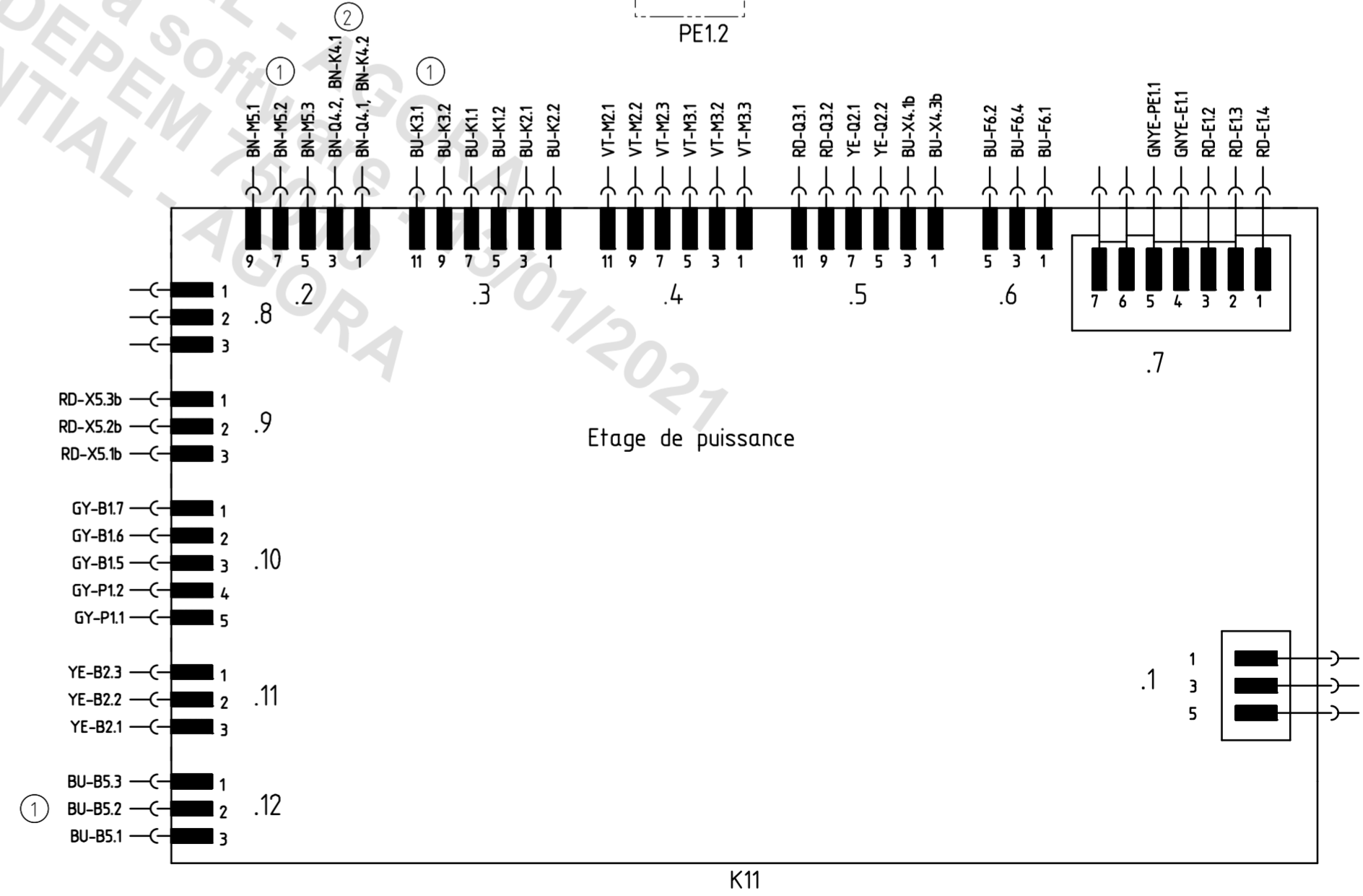
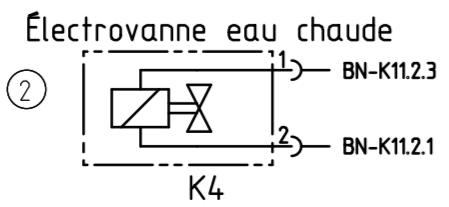
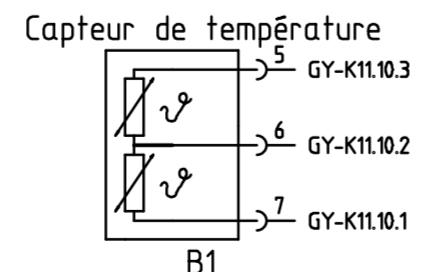
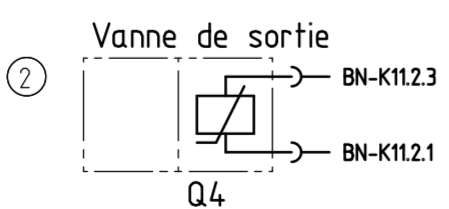
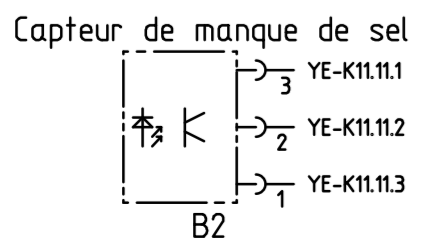
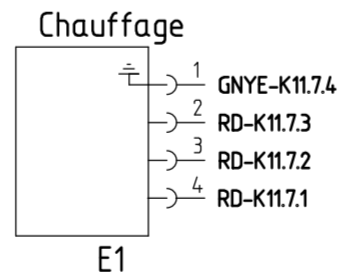
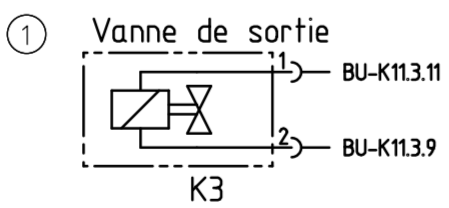
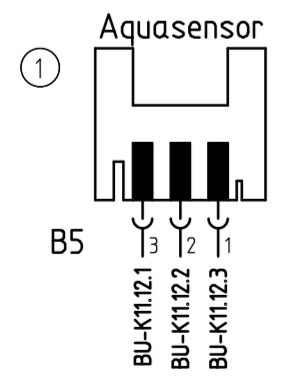
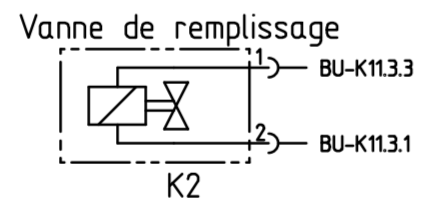
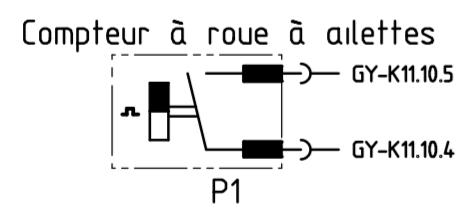
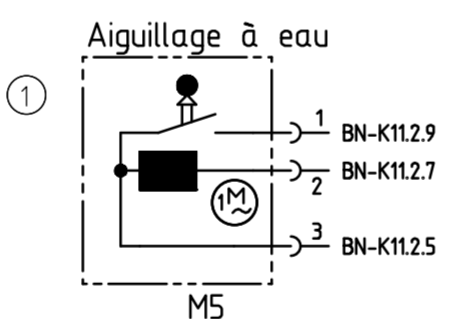
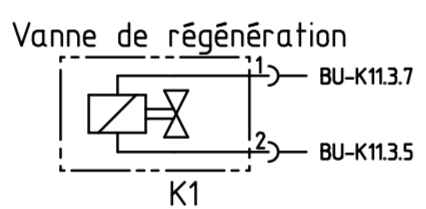
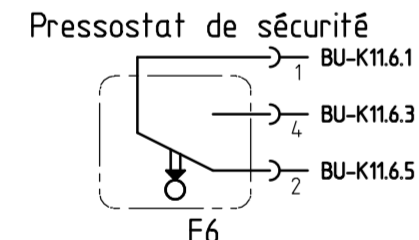
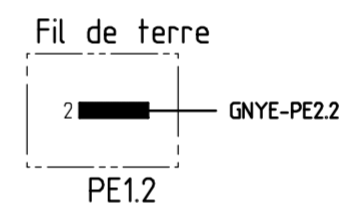
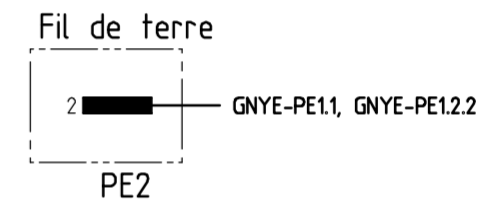
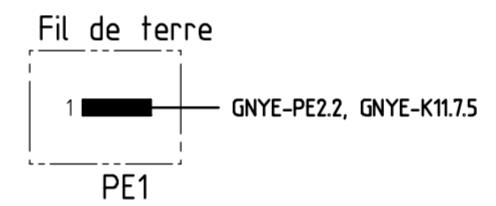
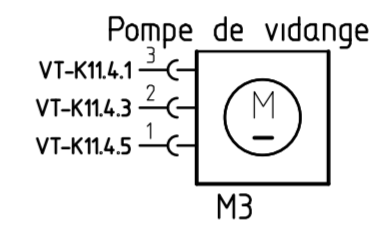
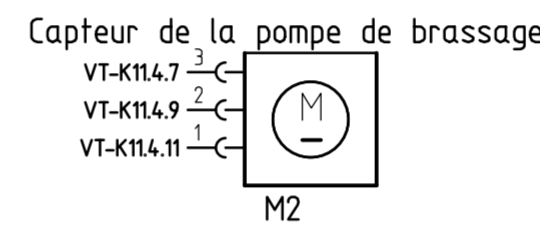
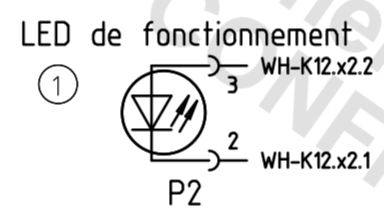
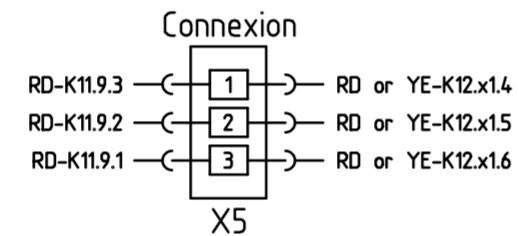
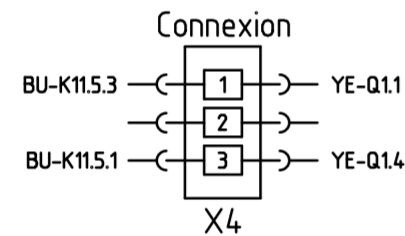
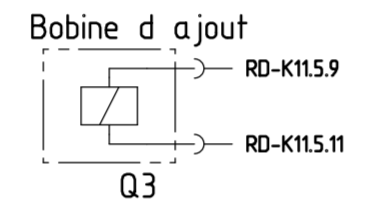
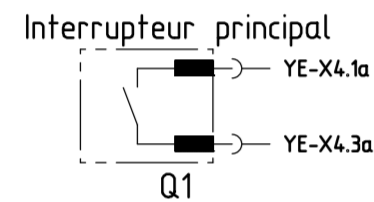
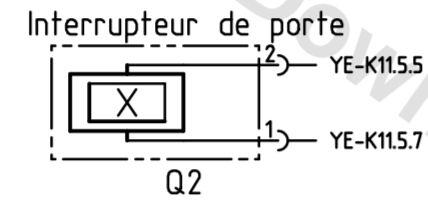
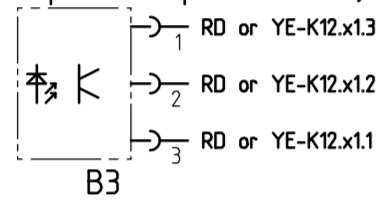

- ① Prsent selon le modle
- ② Prsent selon le modle

The reproduction, transmission or use of this document or its contents is not permitted without express written authority. Offenders will be liable for damages. All rights including rights created by patent grant or registration of a utility model or design are reserved. Copyright reserved.